

### Installation Support • Soporte de Instalación • Support d'Installation

#### Personal Assistance, Product Specs, & "How-to" Questions:

Asistencia personal, especificaciones del producto y preguntas sobre "cómo hacerlo":

Aide personnelle, spécifications du produit et questions « pratique-pratiques » :

**1-800-PFAUCET (732-8238)**  
**pfisterfaucets.com/support**

Installation Videos Available  
Videos de instalación a disposición  
Vidéos d'installation disponibles



[pfisterfaucets.com/videos](http://pfisterfaucets.com/videos)



### WARNING / ADVERTENCIA / AVERTISSEMENT

To reduce the risk of injury or property damage, read all instructions before installing product. Wear safety goggles. Product must be installed in accordance with all state & local plumbing & building codes. Call a professional if you are uncertain about installing this product.

Para disminuir el riesgo de lesiones o daños a la propiedad, lea todas las instrucciones antes de instalar el producto. Utilice gafas de seguridad. El producto deberá instalarse de acuerdo con la normativa de plomería y construcción estatal y local. Llame a un profesional si no está seguro sobre cómo instalar este producto.

Pour réduire le risque de blessures ou de dommages, lire toutes les instructions avant d'installer le produit. Portez des lunettes de sécurité. Il faut installer le produit en respectant tous les codes de construction et de plomberie locaux et d'état. Appelez un professionnel si vous n'êtes pas certain de la façon d'installer ce produit.

### Required Tools

Herramientas necesarias  
Outils nécessaires



Plumber's Putty  
Masilla para plomería  
Mastic de plombier

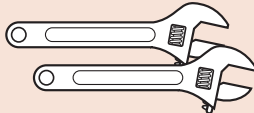

Adjustable Wrenches  
Llaves ajustables  
Clés à mollette



Safety Goggles  
Anteojos de seguridad  
Lunettes de sûreté

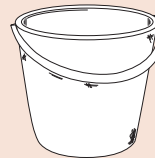

Bucket  
Balde  
Seau

### Additional Helpful Tools

Otras herramientas útiles  
Outils supplémentaires utiles

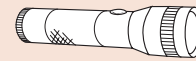

Flashlight  
Linterna  
Lampe De Poche



Cloth  
Paño de limpieza  
Chiffon

### Parts in the Box • Piezas en la caja • Pièces dans la boîte

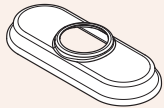

A

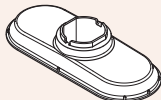

B



C



D

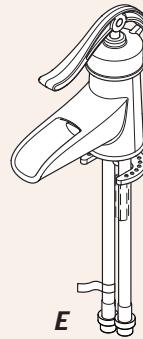

E

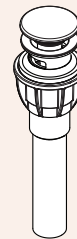

F



G (x2)



H (x2)

## 1 Turn Off Water Supply • Cierre el suministro de agua • Couper l'alimentation en eau



Locate water supply inlets and shut off the water supply valves. These are usually found under the sink or near the water meter. If you are replacing an existing faucet, remove the old faucet from the sink and clean the sink surface thoroughly.

Ubique las entradas del suministro de agua y cierre las válvulas de suministro de agua. Generalmente se encuentran debajo del fregadero o cerca del medidor de agua. Si se trata de un reemplazo de grifo, quite el grifo viejo y limpie completamente la superficie del fregadero.

Recherchez les entrées d'approvisionnement et fermer leurs robinets. Ces robinets se trouvent généralement sous l'évier ou près du compteur d'eau. Si vous remplacez un robinet existant, retirez, le vieux robinet de l'évier et nettoyez soigneusement la surface de ce dernier.

Hot  
Caliente  
Chaud

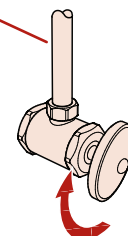

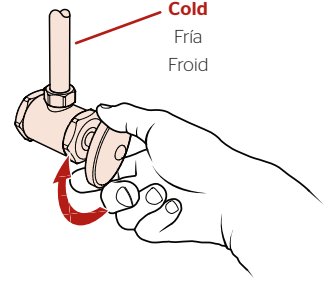

Cold  
Fría  
Froid

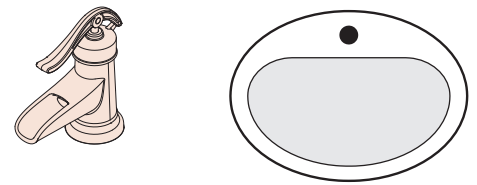

# 2

## OPTION 1: Install Faucet without Deckplate OPCIÓN 1: Instale el grifo sin la placa de cubierta OPTION 1 : Installer le robinet sans le plate-forme





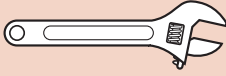

Plumber's Putty  
Masilla para plomería  
Mastic de plombier

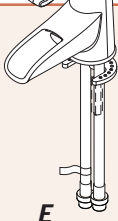

Adjustable Wrench  
Llave ajustable  
Clé réglable



**E**



**C**



**D**

### 2A Disassemble Desensamble Démontez

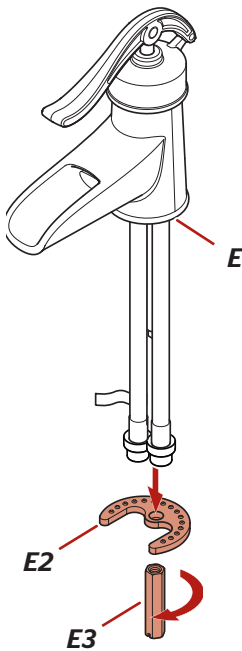

### 2B

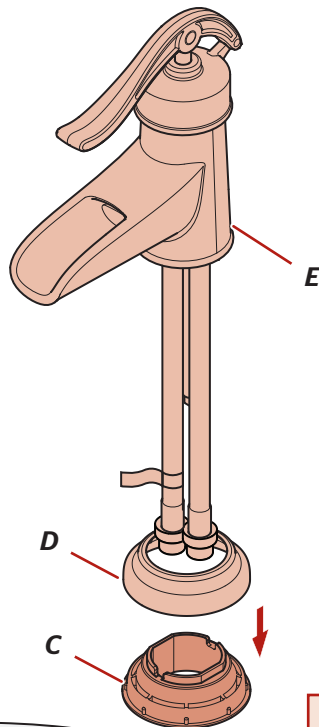

### 2C

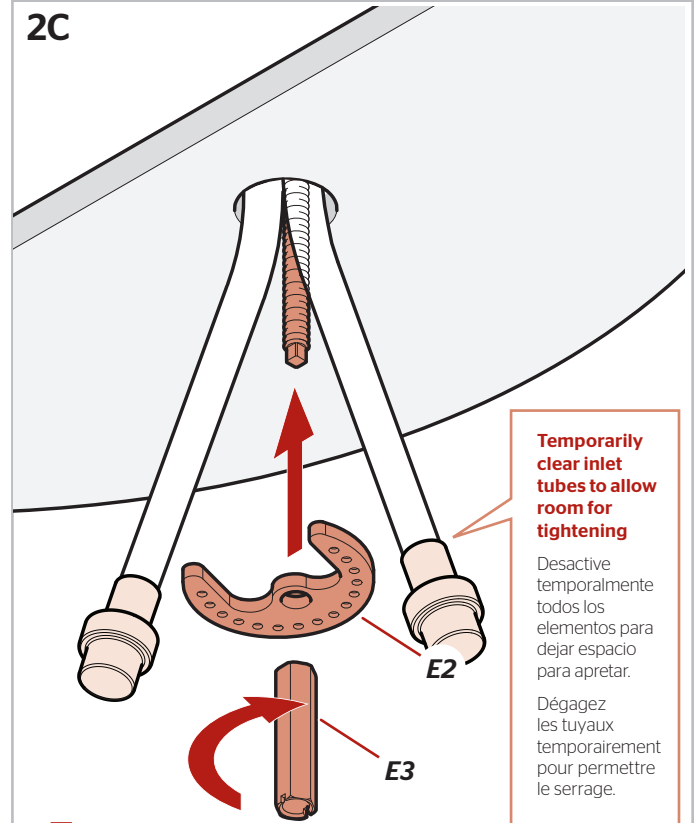

**Make sure that the bumps on the metal washer (E2) are facing up. Be sure the spout body (E) is centered & facing forward. IMPORTANT: DO NOT OVERTIGHTEN.**

Cerciórese que las protuberancias de la arandela metálica (E2) estén orientadas hacia arriba. Cerciórese que la estructura del surtidor (E) esté centrada y orientada hacia adelante. **IMPORTANTE: NO APRIETE EXCESIVAMENTE.**

Assurez-vous que les bosses de la rondelle en métal (E2) sont dirigées vers le haut. Assurez-vous que le corps du bec (E) est centré et tourné vers l'avant. **IMPORTANT: NE PAS TROP SERRER.**

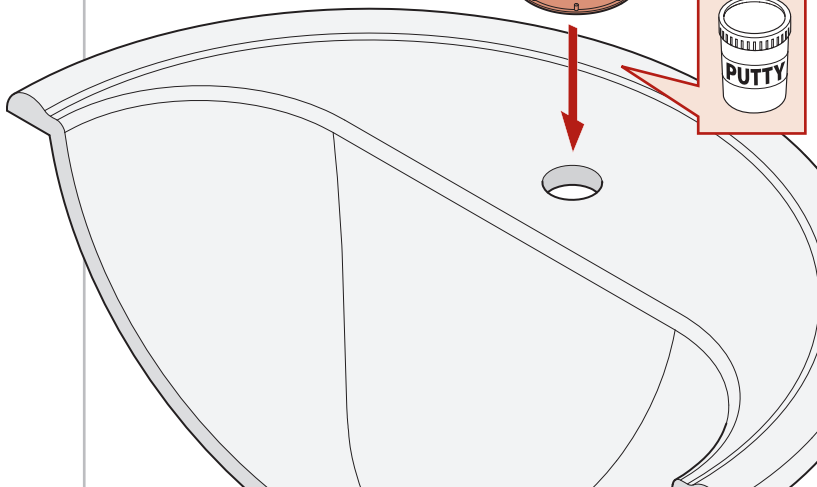

**Apply Plumber's Putty in the groove along the bottom outer edge of Plate (C). Use plumber's putty according to manufacturer's instructions**

Aplique masilla de plomería en la ranura a lo largo del borde exterior de la placa inferior (C). Utilice la masilla del fontanero según manufacturer' instrucciones de s.

Appliquez du mastic de plombier dans la rainure sur le bord extérieur de la plaque (C). Employez le mastic de plombier selon manufacturer' ; instructions de s.

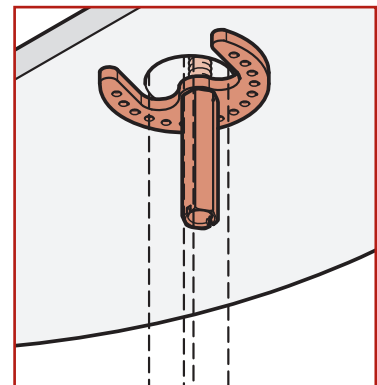

**3** **OPTION 2: Install Faucet with Deckplate**  
**OPCIÓN 2: Instale el grifo con la placa de cubierta**  
**OPTION 2 : Installer le robinet avec le plate-forme**

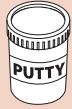

Plumber's Putty  
Masilla para plomería  
Mastic de plombier

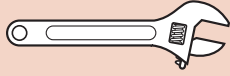

Adjustable Wrench  
Llave ajustable  
Clé réglable

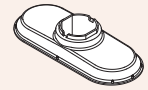
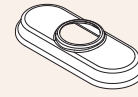
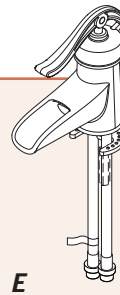
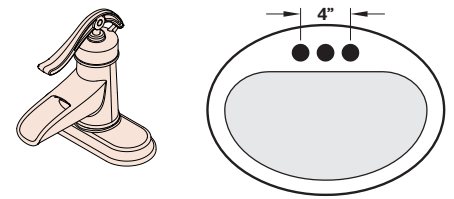

E

A

B

**3A** **Disassemble**  
**Desensamble**  
**Démontez**

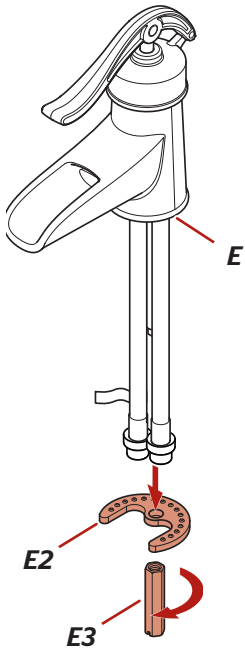

**3B**

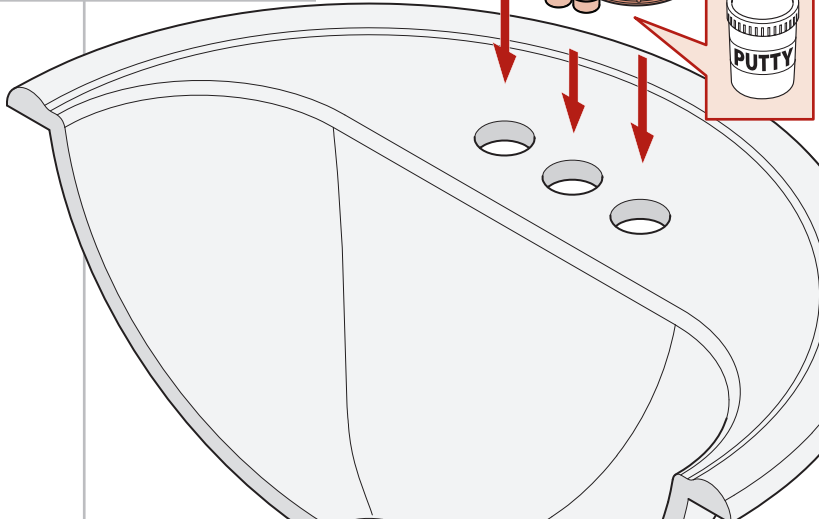
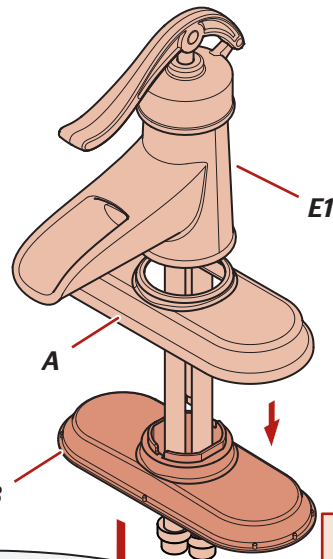

**Apply Plumber's Putty in the groove along the bottom outer edge of Plate (B). Use plumber's putty according to manufacturer's instructions**

Aplique masilla de plomería en la ranura a lo largo del borde exterior de la placa inferior (B). Utilice la masilla del fontanero según manufacturer' instrucciones de s.  
Appliquez du mastic de plombier dans la rainure sur le bord extérieur de la plaque (B). Employez le mastic de plombier selon manufacturer' : instructions de s.

**3C**

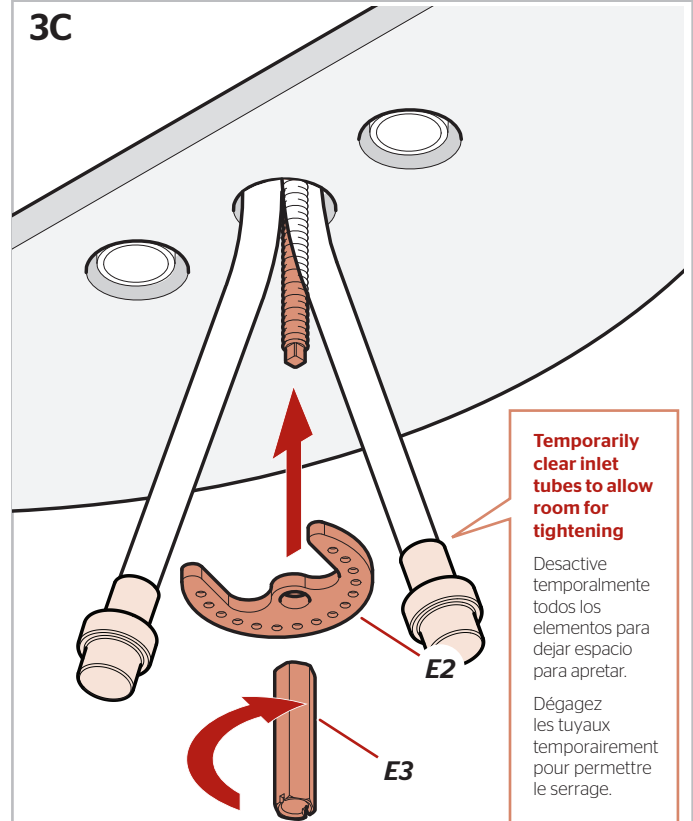

**Temporarily clear inlet tubes to allow room for tightening**

Desactive temporalmente todos los elementos para dejar espacio para apretar.

Dégagez les tuyaux temporairement pour permettre le serrage.



**Make sure that the bumps on the metal washer (E2) are facing up. Be sure the spout body (E) is centered & facing forward. IMPORTANT: DO NOT OVERTIGHTEN.**

Cerciórese que las protuberancias de la arandela metálica (E2) estén orientadas hacia arriba. Cerciórese que la estructura del surtidor (E) esté centrada y orientada hacia adelante. IMPORTANTE: NO APRIETE EXCESIVAMENTE.

Assurez-vous que les bosses de la rondelle en métal (E2) sont dirigées vers le haut. Assurez-vous que le corps du bec (E) est centré et tourné vers l'avant. IMPORTANT: NE PAS TROP SERRER.

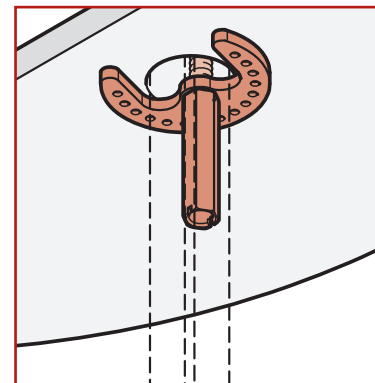

## 4 Connect Water Supply Lines Conecte las tuberías de suministro de agua Raccorder les conduites d'alimentation en eau

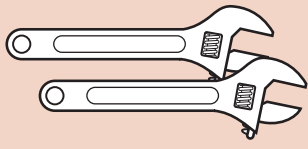

Adjustable Wrenches  
Llaves ajustables  
Clés à mollette

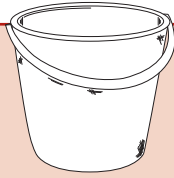

Bucket  
Balde  
Seau



G (x2)



H (x2)

**!** Water Supply Lines not included. Please consult manufacturer and/or its instructions for the correct method of installation of supply lines & fittings. **IMPORTANT: Incorrect application of supply lines and fittings may result in the failure or leak of the supply lines and fitting.**

Las tuberías de suministro de agua no están incluidas. Consulte por favor el fabricante y/o sus instrucciones para el método correcto de instalación de líneas de suministro y de guarniciones.

**IMPORTANT:** El uso incorrecto de líneas de suministro y de guarniciones puede dar lugar a la falta o al escape de las líneas de suministro y de la guarnición.

Les tuyaux d'arrivée d'eau ne sont pas fournis. Veuillez consulter le fabricant et/ou ses instructions pour la méthode correcte d'installation des conduites d'alimentation en eau et des accessoires.

**IMPORTANT:** Mauvaise application des lignes d'alimentation et accessoires peut entraîner la défaillance ou la fuite.

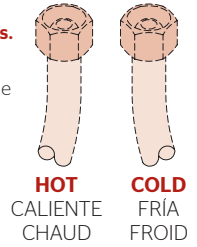

**HOT**  
CALIENTE  
CHAUD

**COLD**  
FRÍA  
FROID

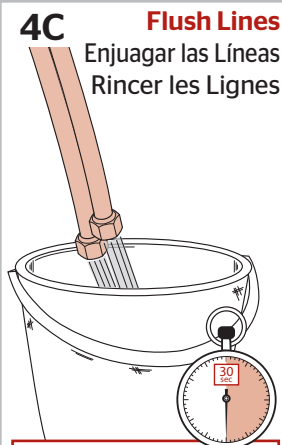
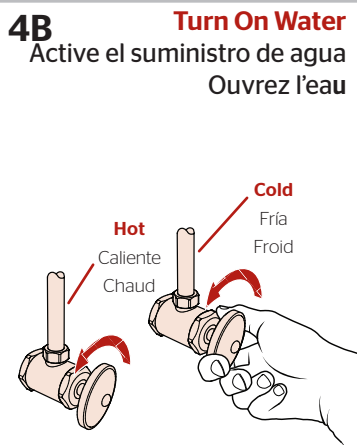
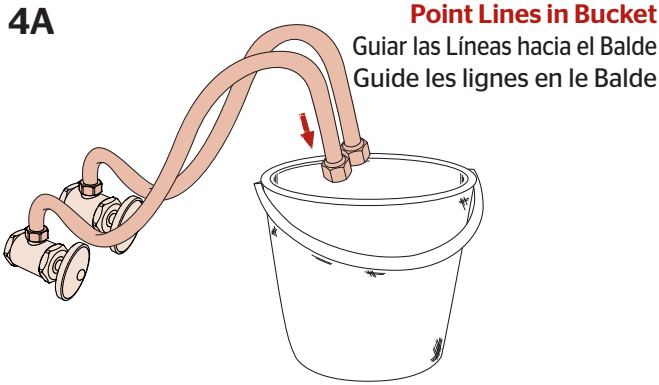

**Allow water to run for at least 30 seconds.**

Deje correr el agua durante al menos 30 segundos.  
Permettez à l'eau couler au moins 30 secondes.

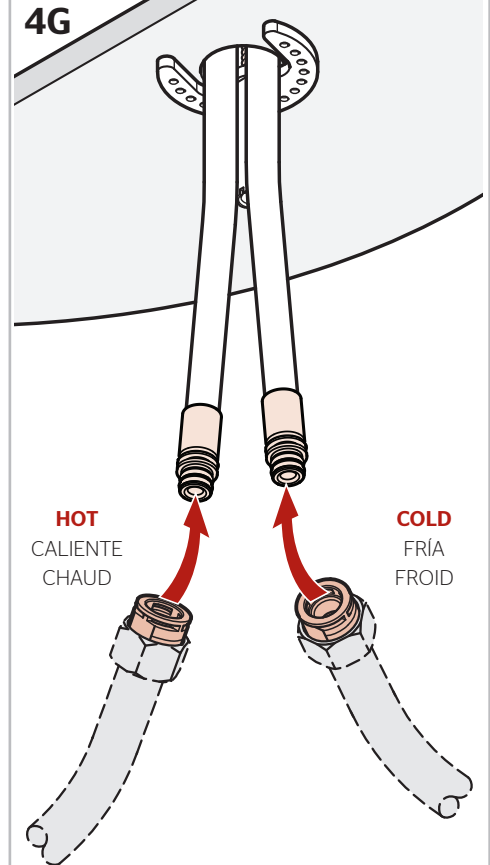
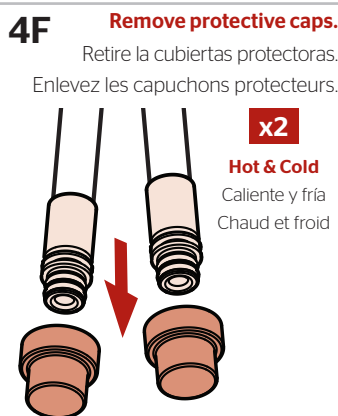
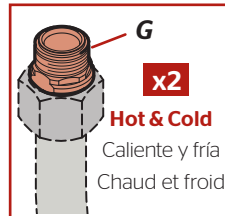
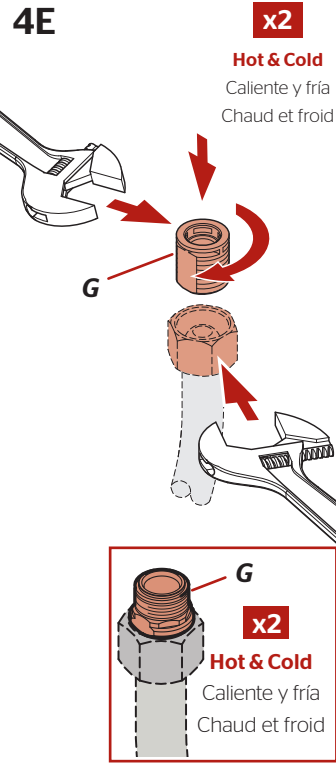
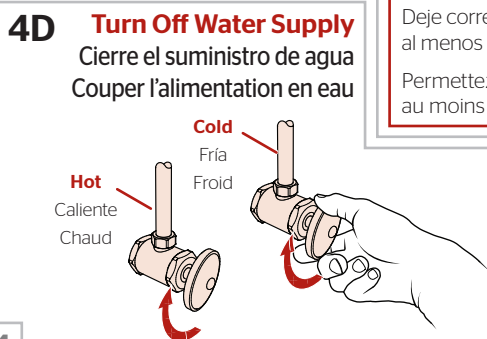

**HOT**  
CALIENTE  
CHAUD

**COLD**  
FRÍA  
FROID

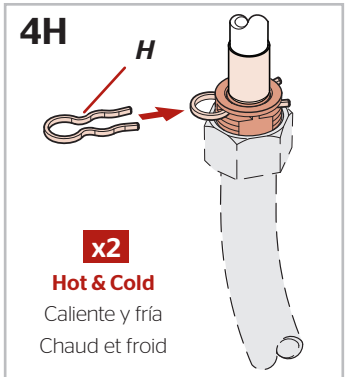

# 5 Prepare & Install Push & Seal™ Drain

## Prepare y instale cuerpo de drenaje Push & Seal™

### Préparez & installez le corps de drainage Push & Seal™

No Tools Required for This Step  
 No se necesitan herramientas para este paso  
 Pas d'outil nécessaire pour cette étape

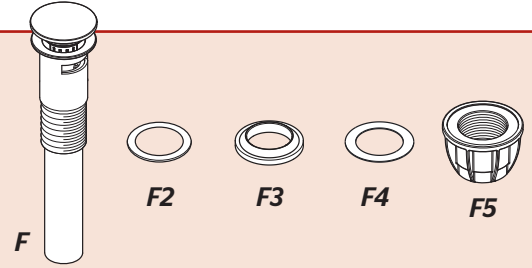

#### 5A Disassemble Pop-Up

##### Desensamble el cuerpo de drenaje

##### Démontez le corps de drainage

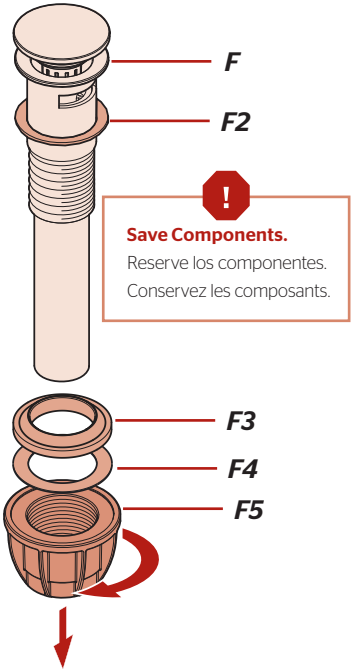

#### 5B

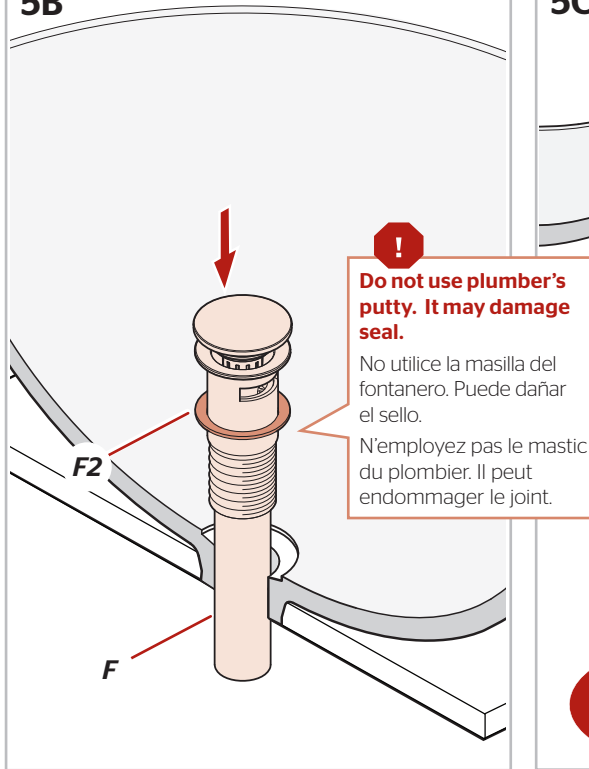

#### 5C

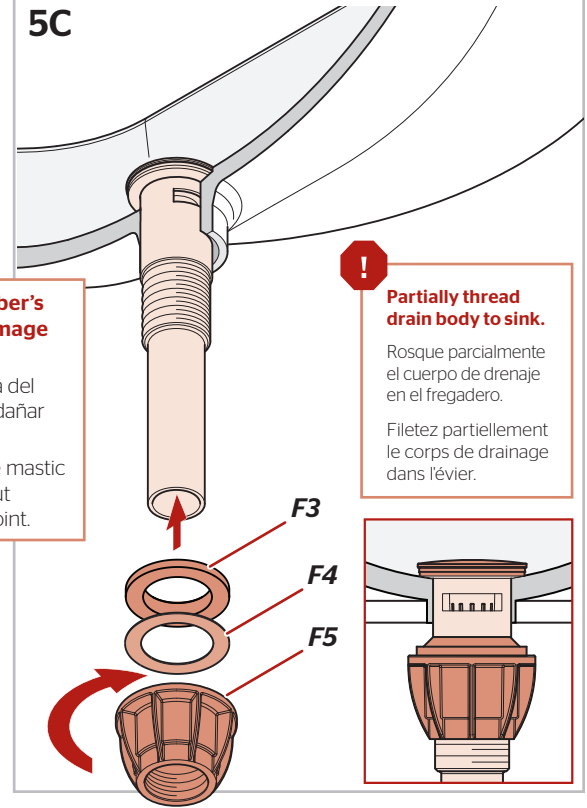

#### 5D

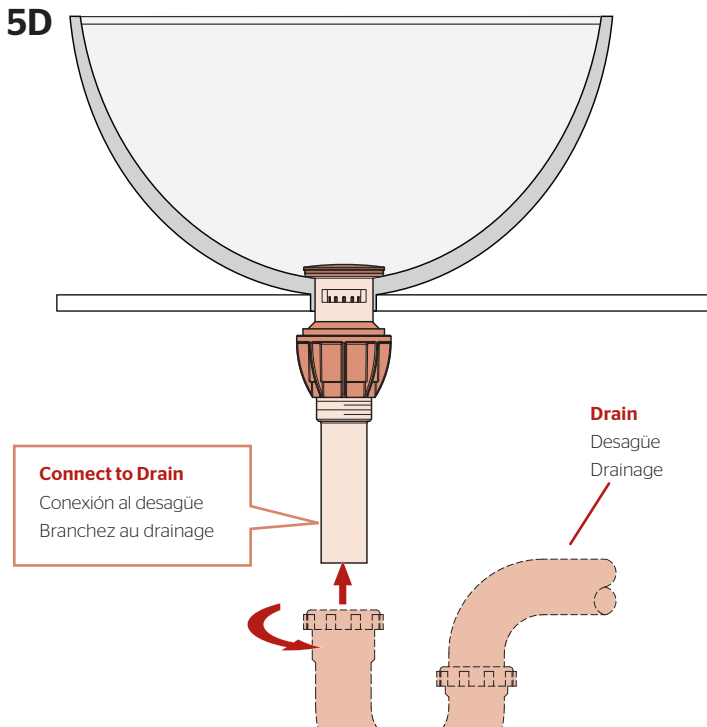

#### 5E

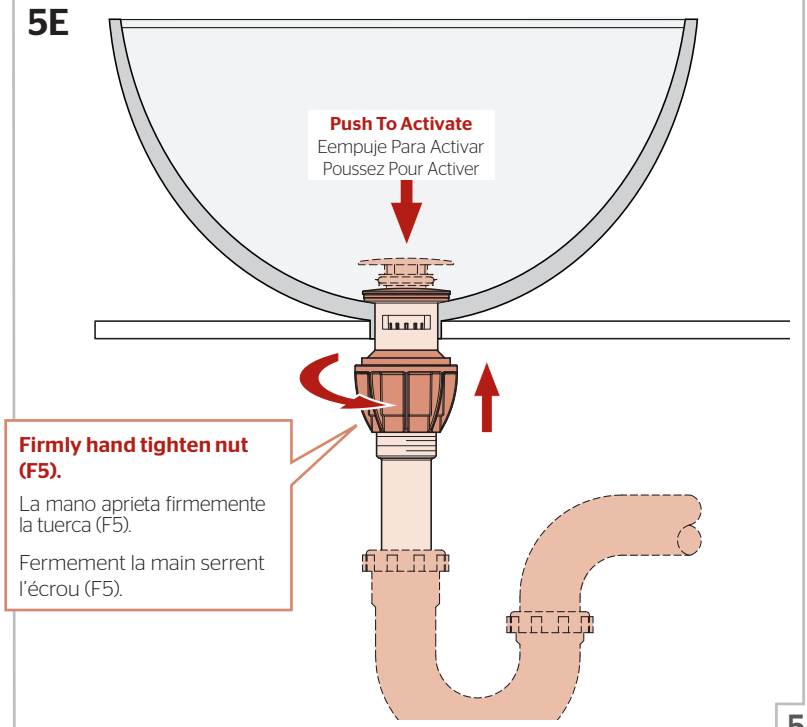

## 6 Turn On Water & Confirm Proper Installation

Active el suministro de agua y confirme que la instalación está adecuadamente efectuada

Ouvrez l'eau et confirmez que l'installation est correcte

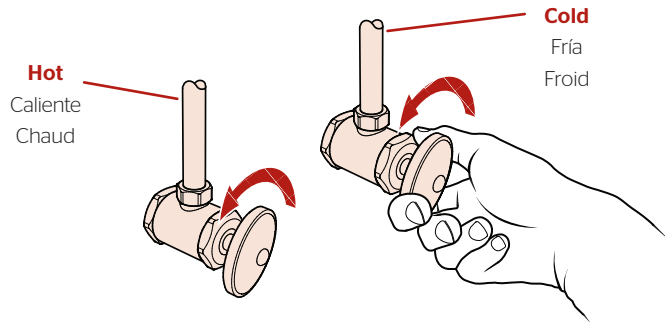

### Check for leaks above and below the sink.

Revise si hay fugas encima y debajo del fregadero

Assurez-vous qu'il n'y a pas de fuite au dessus ou au dessous du lavabo.

## 7 Faucet Function

Funciones del grifo

Fonctionnement du robinet

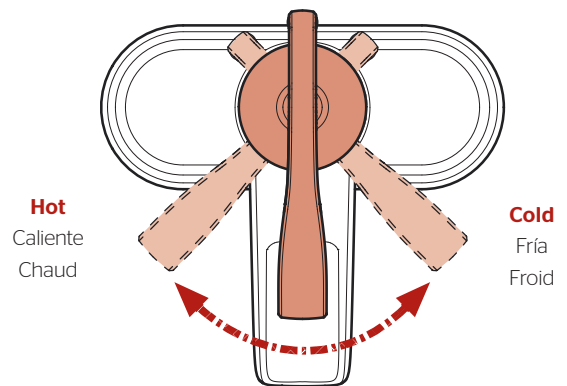
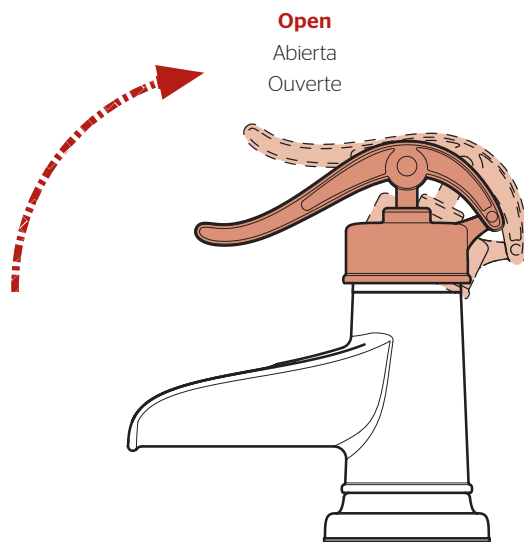

**For Additional Installation Help:**  
Para la instalación adicionales de ayuda:  
Pour les aides supplémentaires à l'installation:

**Pfister**

**1-800-PFAUCET (732-8238)**  
**pfisterfaucets.com**